

2019.M30



2019L003A2EL



Coimisiún na Scrúduithe Stáit
State Examinations Commission

Leaving Certificate Examination 2019

Mathematics

Paper 2

Higher Level

Monday 10 June – Morning 9:30 to 12:00

300 marks

Examination Number

| | | | | | |
|--|--|--|--|--|--|
| | | | | | |
|--|--|--|--|--|--|

Centre Stamp

| |
|--|
| |
|--|



2019L003A2EL0128

Do not write on this page

Instructions

There are **two** sections in this examination paper.

| | | | |
|-----------|---------------------------|-----------|-------------|
| Section A | Concepts and Skills | 150 marks | 6 questions |
| Section B | Contexts and Applications | 150 marks | 3 questions |

Answer all nine questions.

Write your Examination Number in the box on the front cover.

Write your answers in blue or black pen. You may use pencil in graphs and diagrams only.

This examination booklet will be scanned and your work will be presented to an examiner on screen. Anything that you write outside of the answer areas may not be seen by the examiner.

Write all answers into this booklet. There is space for extra work at the back of the booklet. If you need to use it, label any extra work clearly with the question number and part.

The superintendent will give you a copy of the *Formulae and Tables* booklet. You must return it at the end of the examination. You are not allowed to bring your own copy into the examination.

You will lose marks if your solutions do not include relevant supporting work.

You may lose marks if the appropriate units of measurement are not included, where relevant.

You may lose marks if your answers are not given in simplest form, where relevant.

Write the make and model of your calculator(s) here:



Answer **all six** questions from this section.

Question 1**(25 marks)**

(a) A class consists of 12 boys and 8 girls.

- (i) Two students are selected at random from the class. What is the probability that the two students selected will be a boy and a girl in any order?

- (ii) Four students are selected, one at a time, at random from the class. What is the probability that the **first three** students selected will be boys and the fourth will be a girl?

- (b) An examination paper is made up of two sections, Section A consisting of 7 questions and Section B consisting of 8 questions. The paper contains the following instruction:
*“From section A you must answer question 1 and any three other questions.
From Section B you must also answer any four questions.”*
Find how many different combinations of questions may be answered if a candidate follows this instruction.

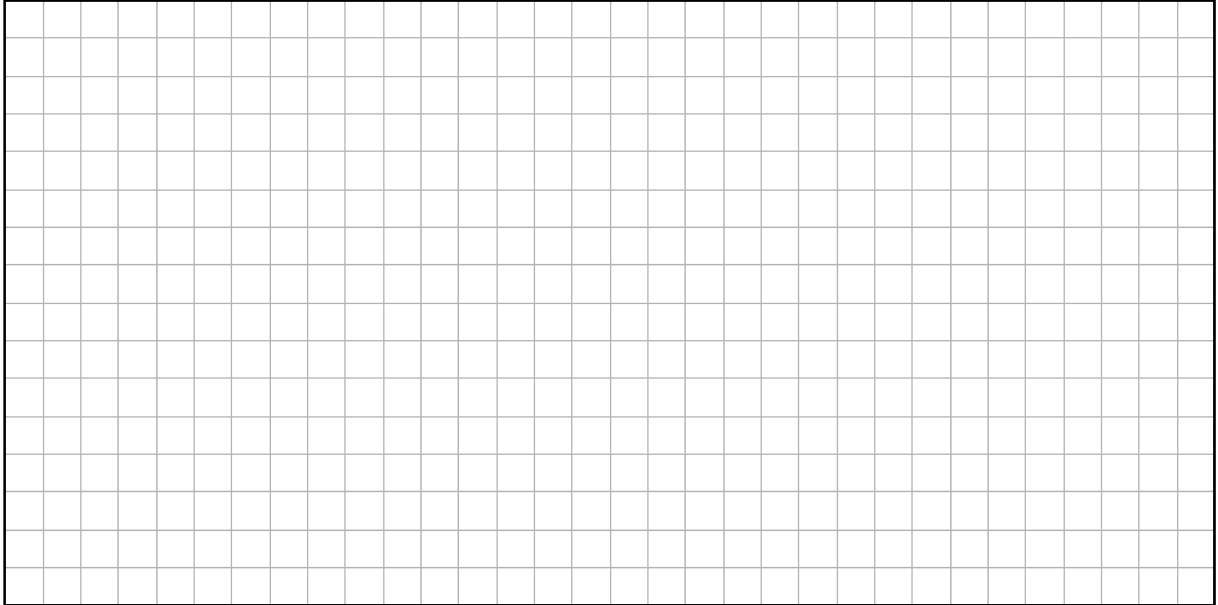

Question 2

(25 marks)

- (a)** The line p makes an intercept on the x -axis at $(a, 0)$ and on the y -axis at $(0, b)$, where $a, b \neq 0$.

Show that the equation of p can be written as $\frac{x}{a} + \frac{y}{b} = 1$.

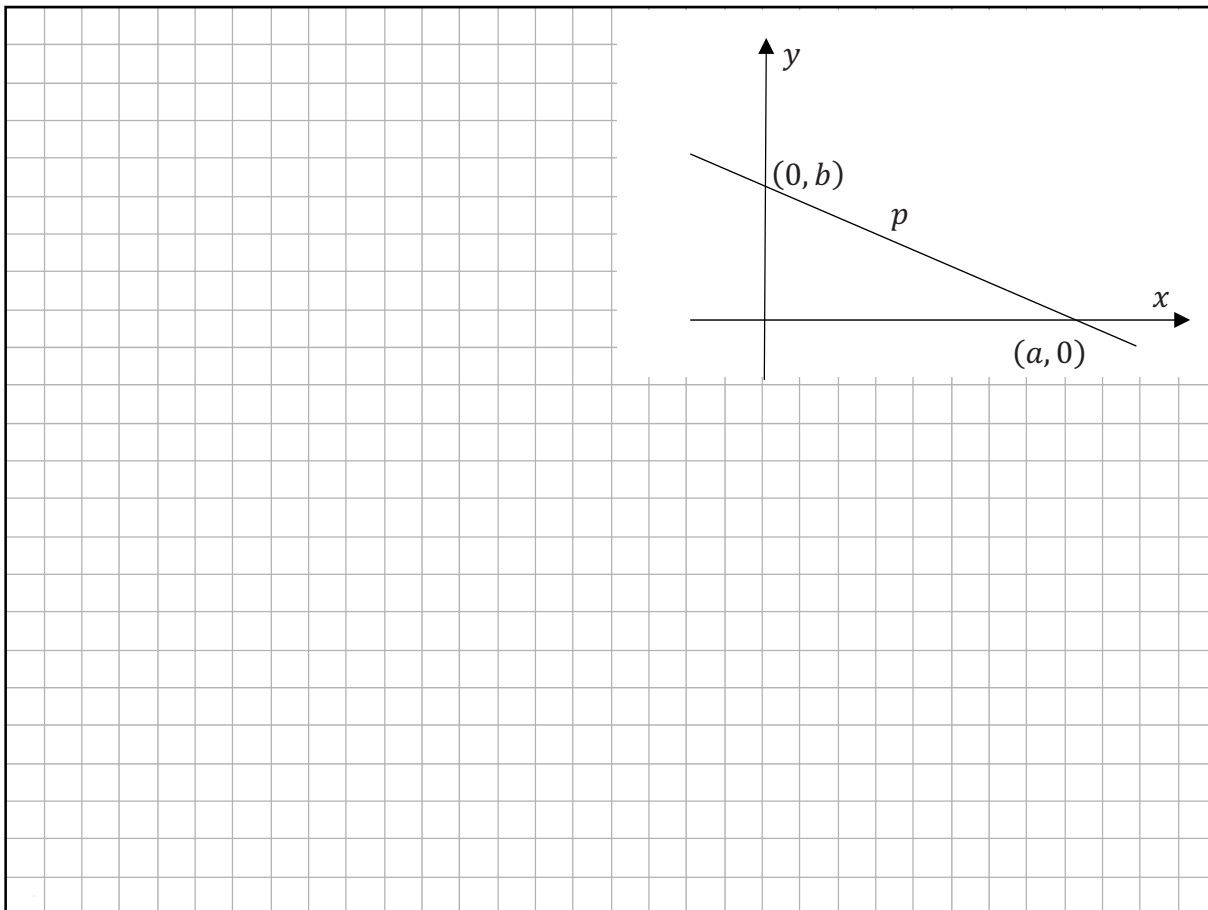

- (b)** The line l has a slope m , and contains the point $A(6, 0)$.

- (i)** Write the equation of the line l in terms of m .

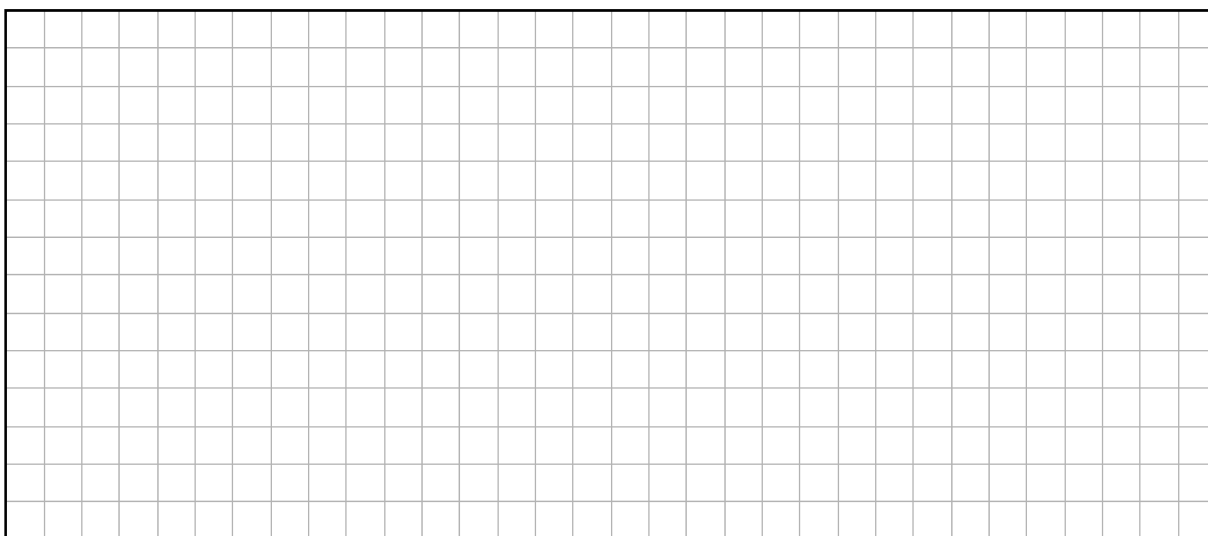

- (ii) The line l cuts the line $k: 4x + 3y = 25$ at P .
Find the co-ordinates of P in terms of m .
Give each co-ordinate as a fraction in its simplest form.

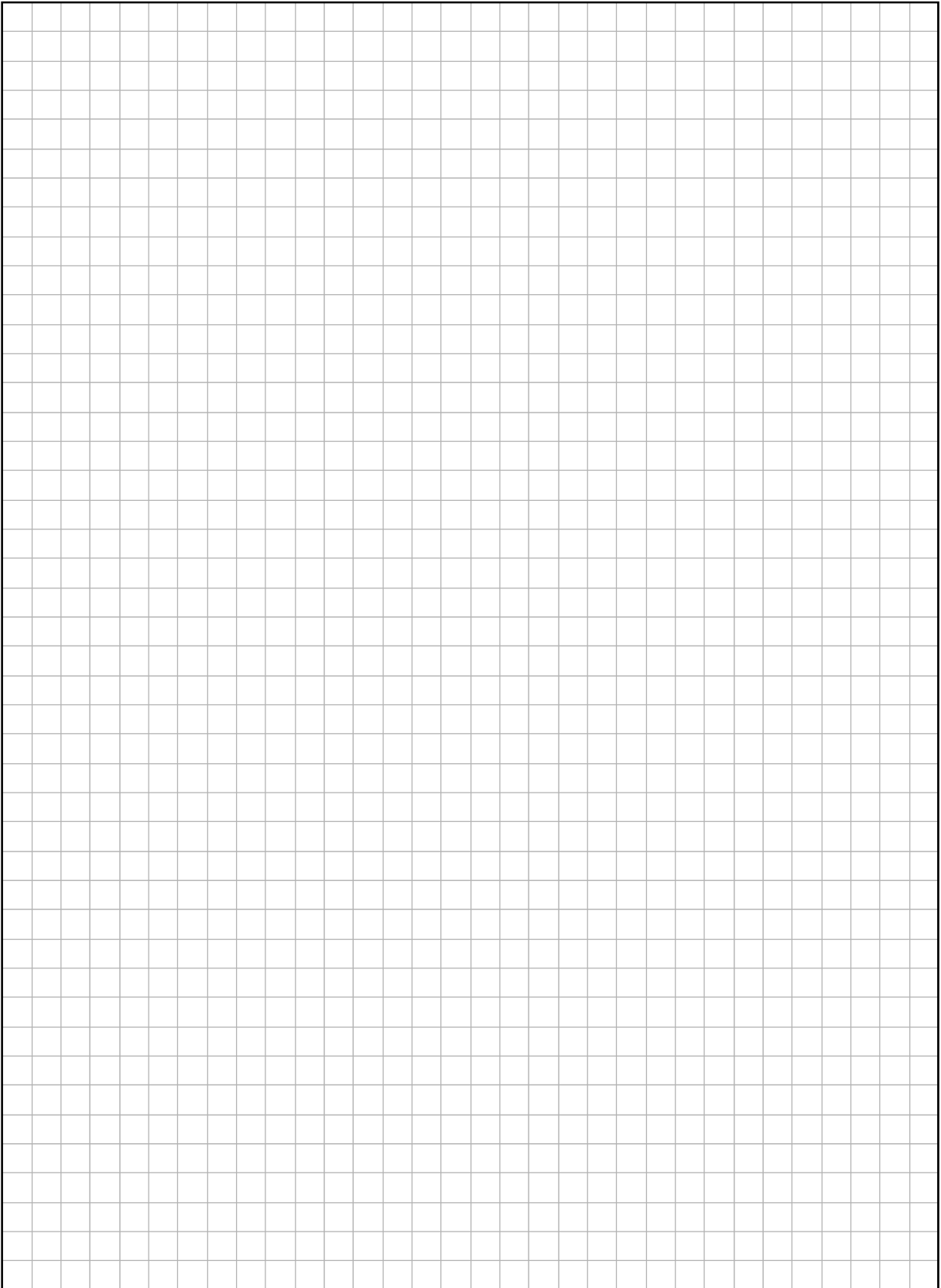

Question 3

(25 marks)

- (a) The point $(-2, k)$ is on the circle $(x - 2)^2 + (y - 3)^2 = 65$.
Find the two possible values of k , where $k \in \mathbb{Z}$.

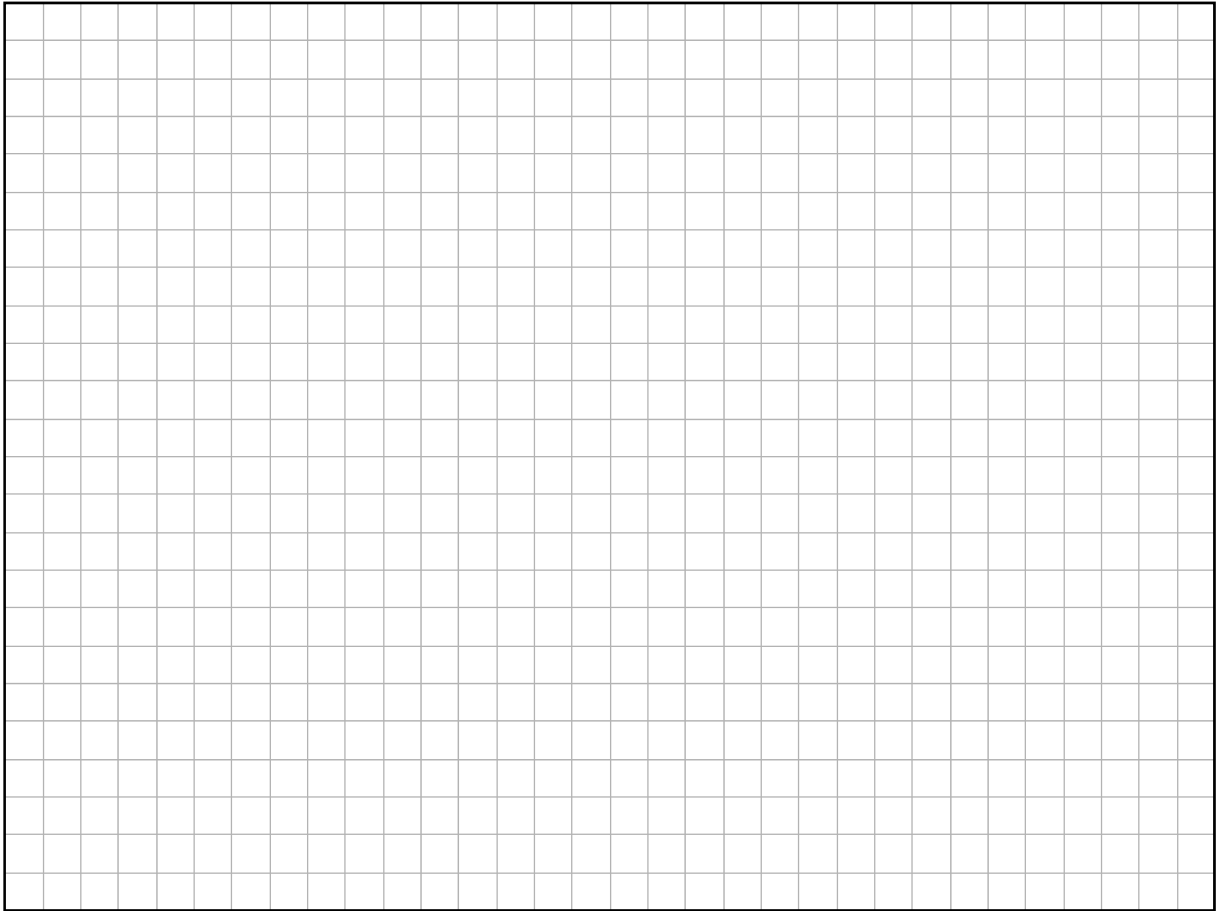

- (b) The circle s is in the first quadrant. It touches both the x -axis and the y -axis. The line $t: 3x - 4y + 6 = 0$ is a tangent to s as shown. Find the equation of s .

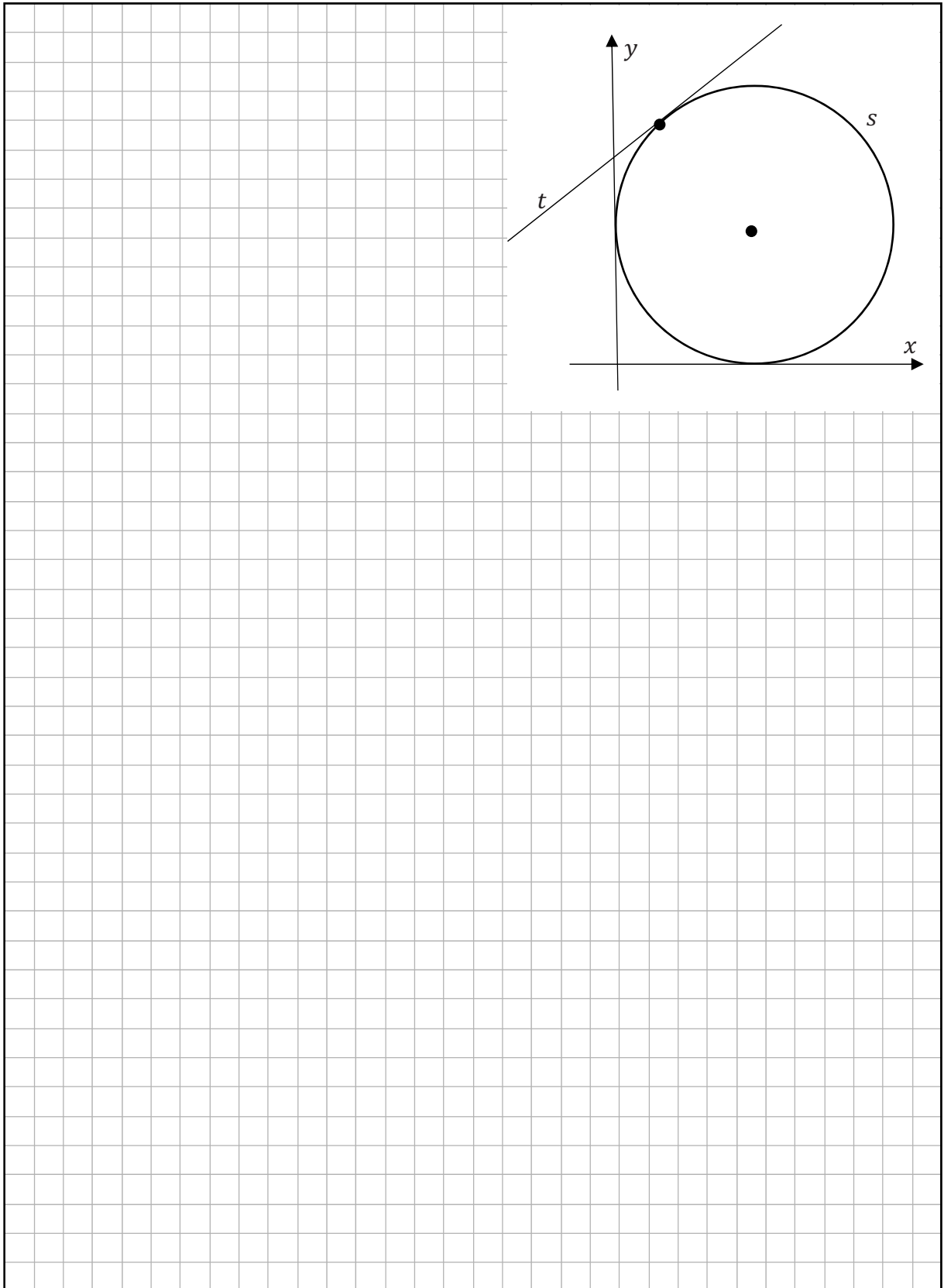

Question 4

(25 marks)

(a) Show that $\cos 2\theta = 1 - 2 \sin^2 \theta$.

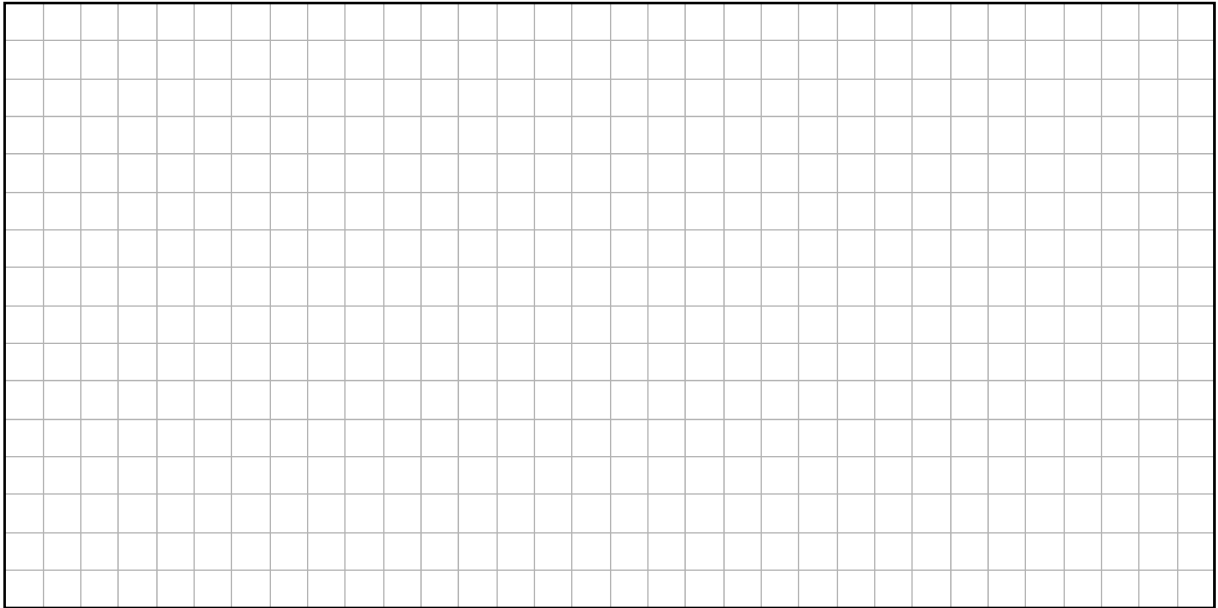

(b) Find the cosine of the acute angle between two diagonals of a cube.

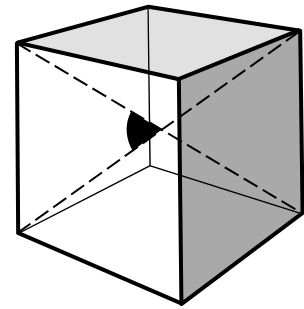

Question 5

(25 marks)

- (a)** Construct and **label** the orthocentre of the triangle ABC in the diagram below. Show any construction lines or arcs clearly.

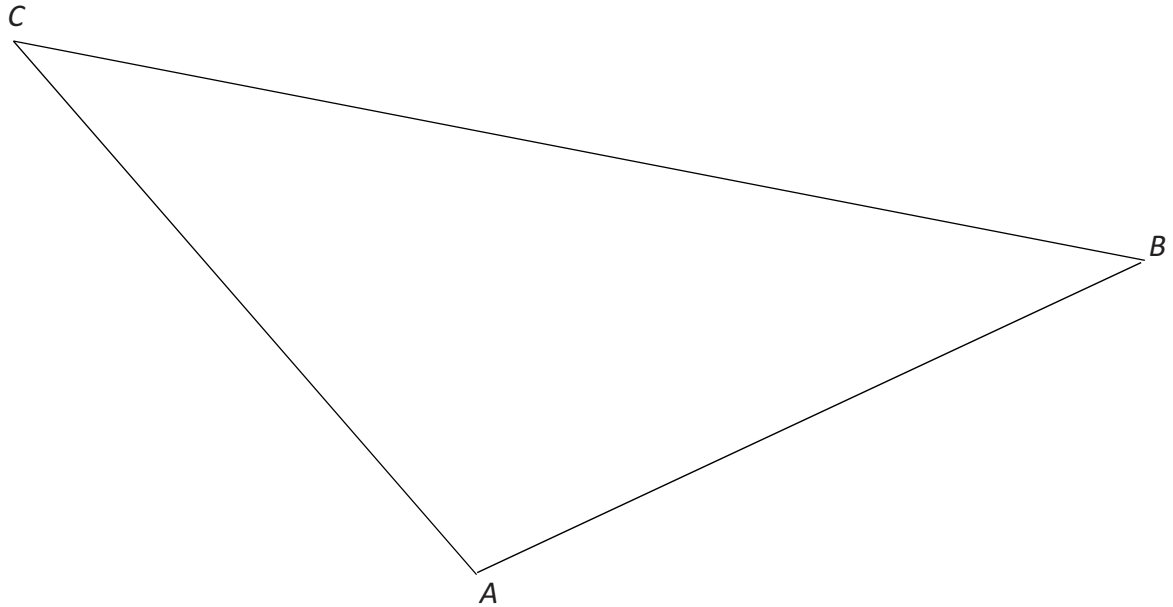

- (b) In the diagram below O is the centre of circle s . $[AB]$ is a diameter of s .
 BE is a tangent to s at point B .
 $[CD]$ is a chord of circle s .
 $|CD| = \frac{1}{2}|AB|$ and CD is parallel to AB .
 Find, with justification, $|\angle BEA|$.

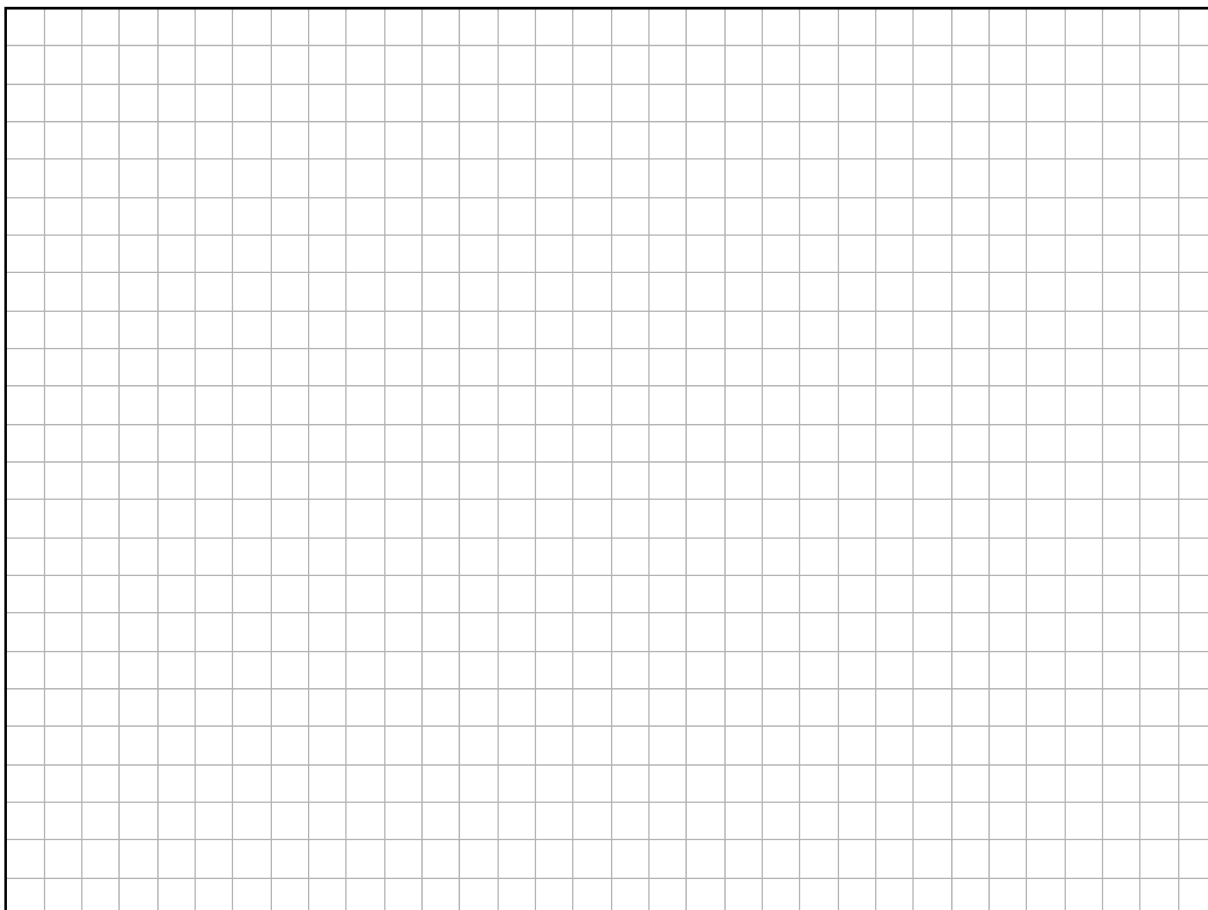
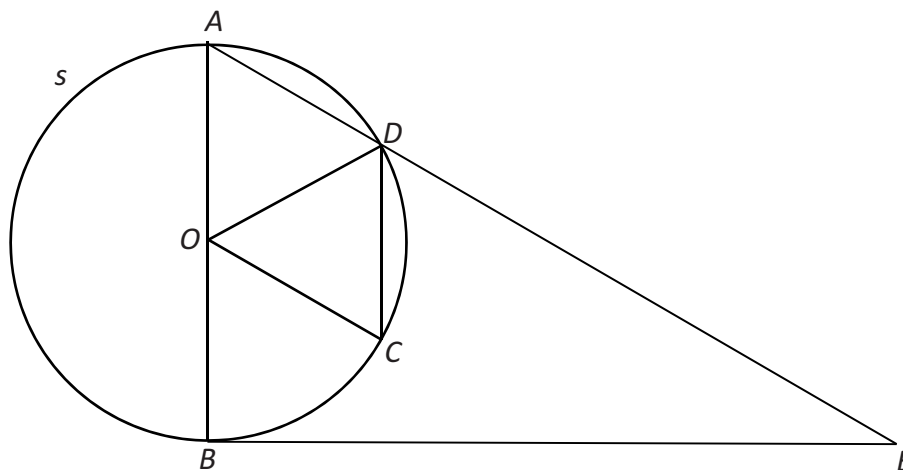

Question 6

(25 marks)

- (a) Two **independent** events F and S are represented in the Venn diagram shown below.
 $P(F \setminus S) = \frac{1}{4}$, $P(F \cap S) = \frac{1}{5}$, $P(S \setminus F) = x$, and $P(F \cup S)' = y$, where $x, y \neq 0$.
 Find the value of x and the value of y .

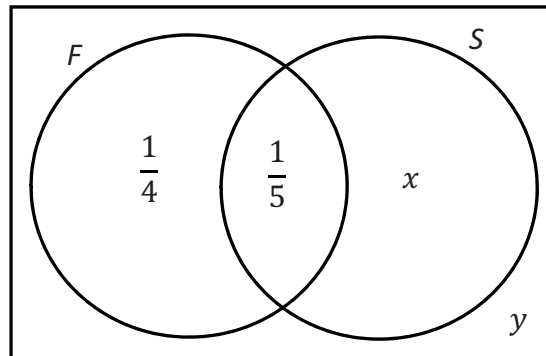

$x =$

$y =$



- (b) In a club there are German, Irish and Spanish children only.
There are 10 Spanish children.
There are twice as many Irish children as German children.

They are all in a group waiting to get on a swing.
One child will be selected at random to go first and will not re-join the group.
Then a second child will be selected at random to go next.

The probability that the first child selected will be German and that the second child selected will not be German is $\frac{1}{6}$
Find how many children are in the club.

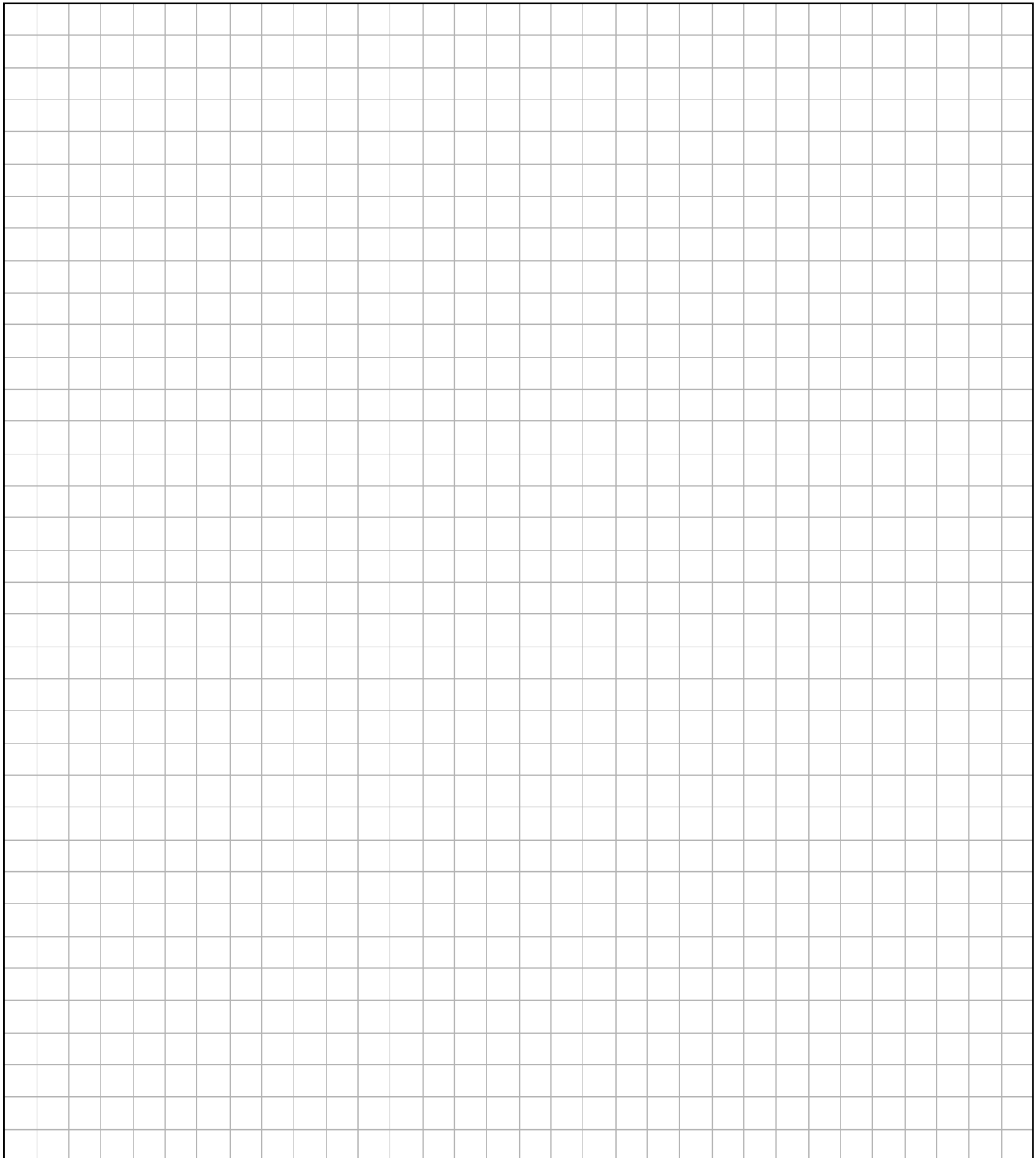

Answer **all three** questions from this section.

Question 7

(50 marks)

- (a) A cattle feeding trough of uniform cross section and 2.5 m in length, is shown in **Figure 1**.
 The front of the trough (segment ABC) is shown in **Figure 2**.
 The front of the trough is a segment of a circle of radius 90 cm.
 The height of the trough, $|DB|$, is 30 cm.
 $|OA| = |OC| = |OB| = 90$ cm. $[OB] \perp [AC]$.

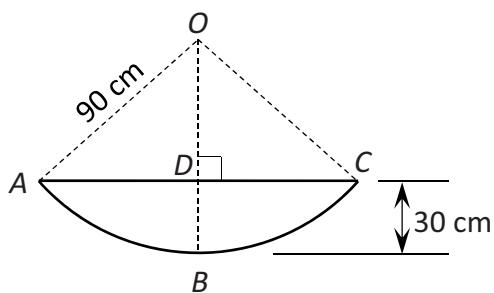

Figure 2

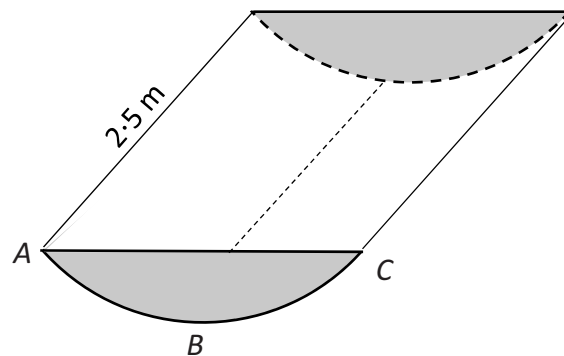
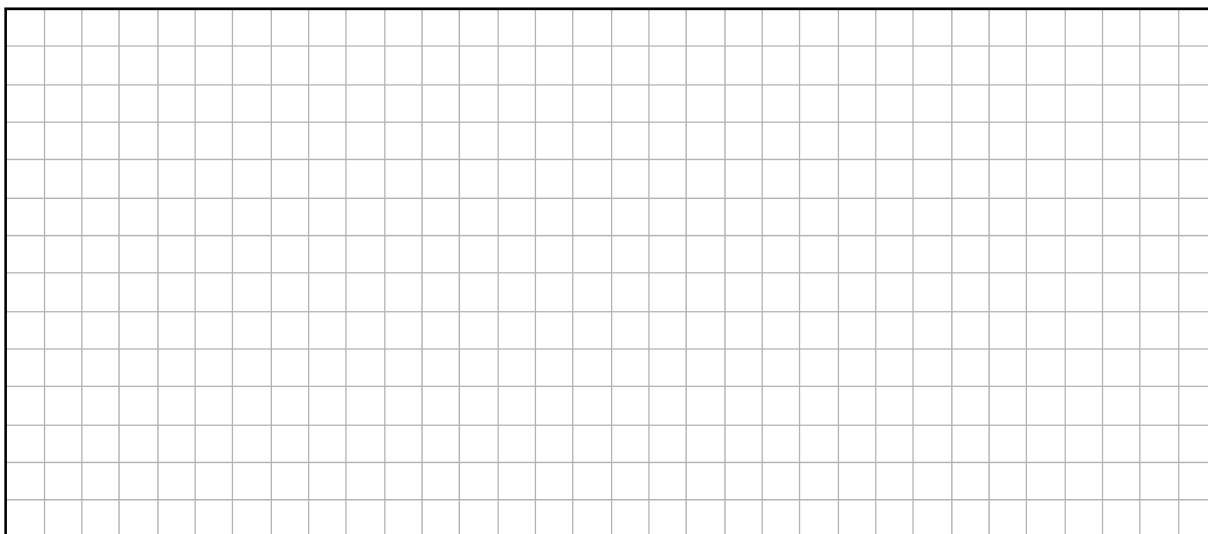
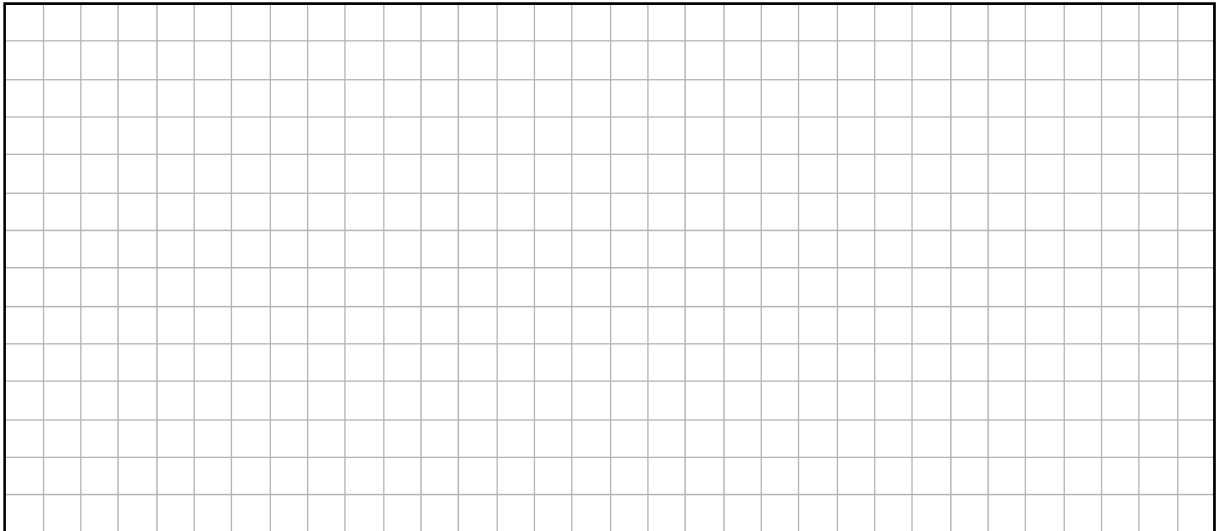

Figure 1

- (i) Find $|AD|$. Give your answer in the form $a\sqrt{b}$ cm, where $a, b \in \mathbb{Z}$.



(ii) Find $|\angle DOA|$. Give your answer in radians, correct to 2 decimal places.



(iii) Find the area of the **segment** ABC . Give your answer in m^2 correct to 2 decimal places.

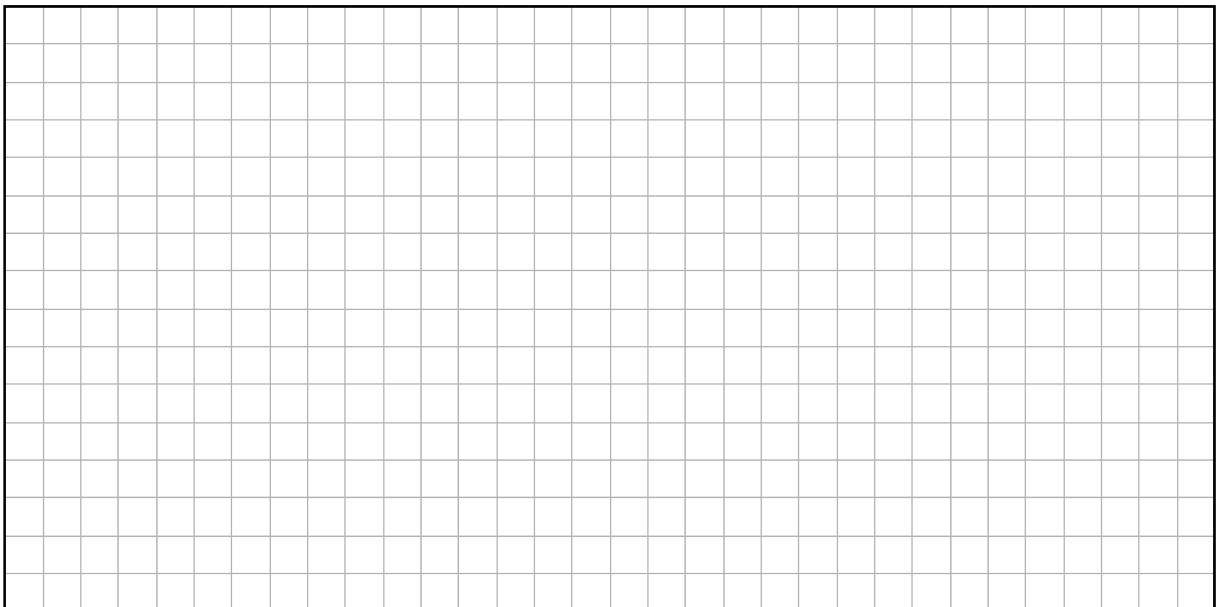

(iv) Find the **volume** of the trough. Give your answer in m^3 , correct to 2 decimal places.

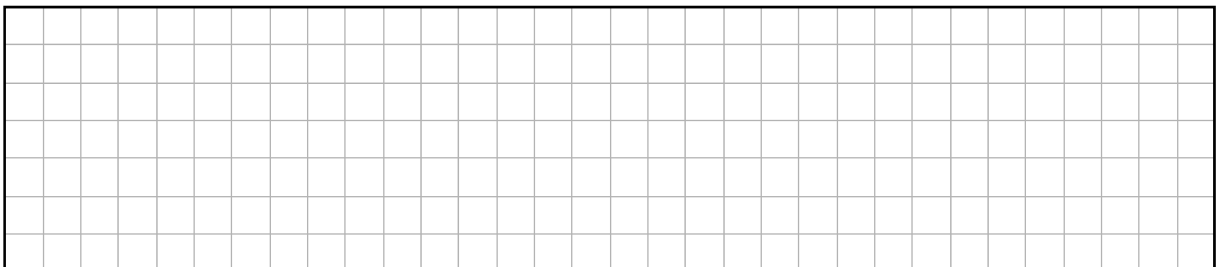

This question continues on the next page.

- (b) A sand timer for games is shown in the diagram. Each half of the timer consists of a hemisphere, a cylinder of height 3.5 cm and a cone of height 1.5 cm. All of the parts have a radius of 1.25 cm.

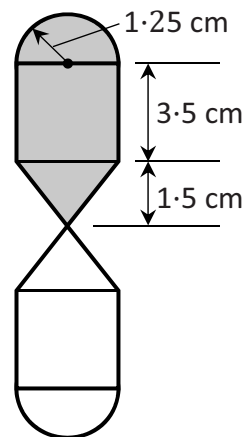

- (i) The upper half of the timer is full of sand. Find the volume of sand in the upper half of the timer. Give your answer in cm^3 correct to 2 decimal places.

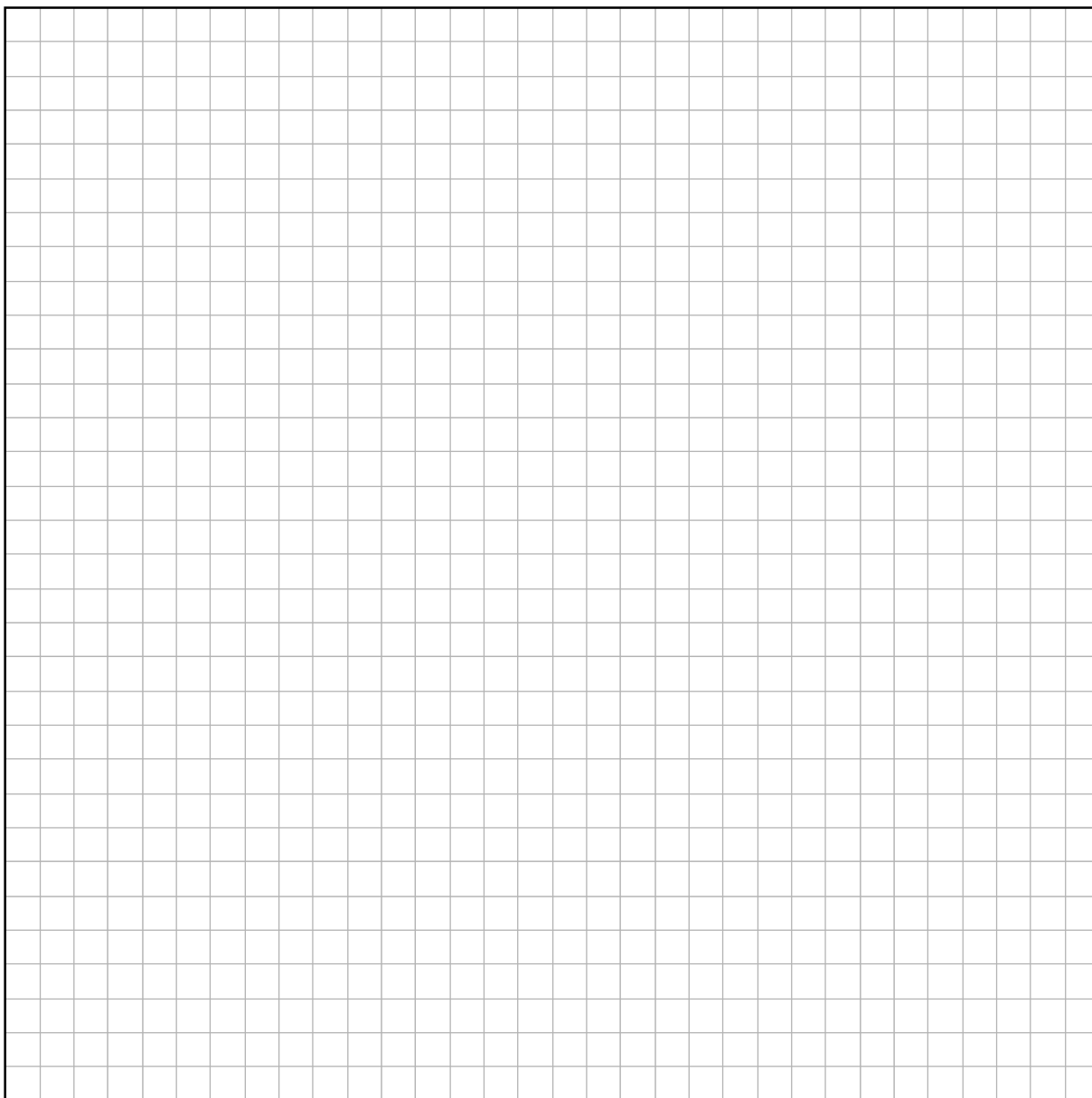

- (ii) Sand flows from the top half of the timer into the bottom part.
 As it flows the top surfaces in both parts remain level.
 At a certain time, 98% of the sand has flowed into the bottom half of the timer.
 Find h , the height of the remaining sand (in the conical part of the top of the timer).
 Give your answer in cm, correct to 2 decimal places.

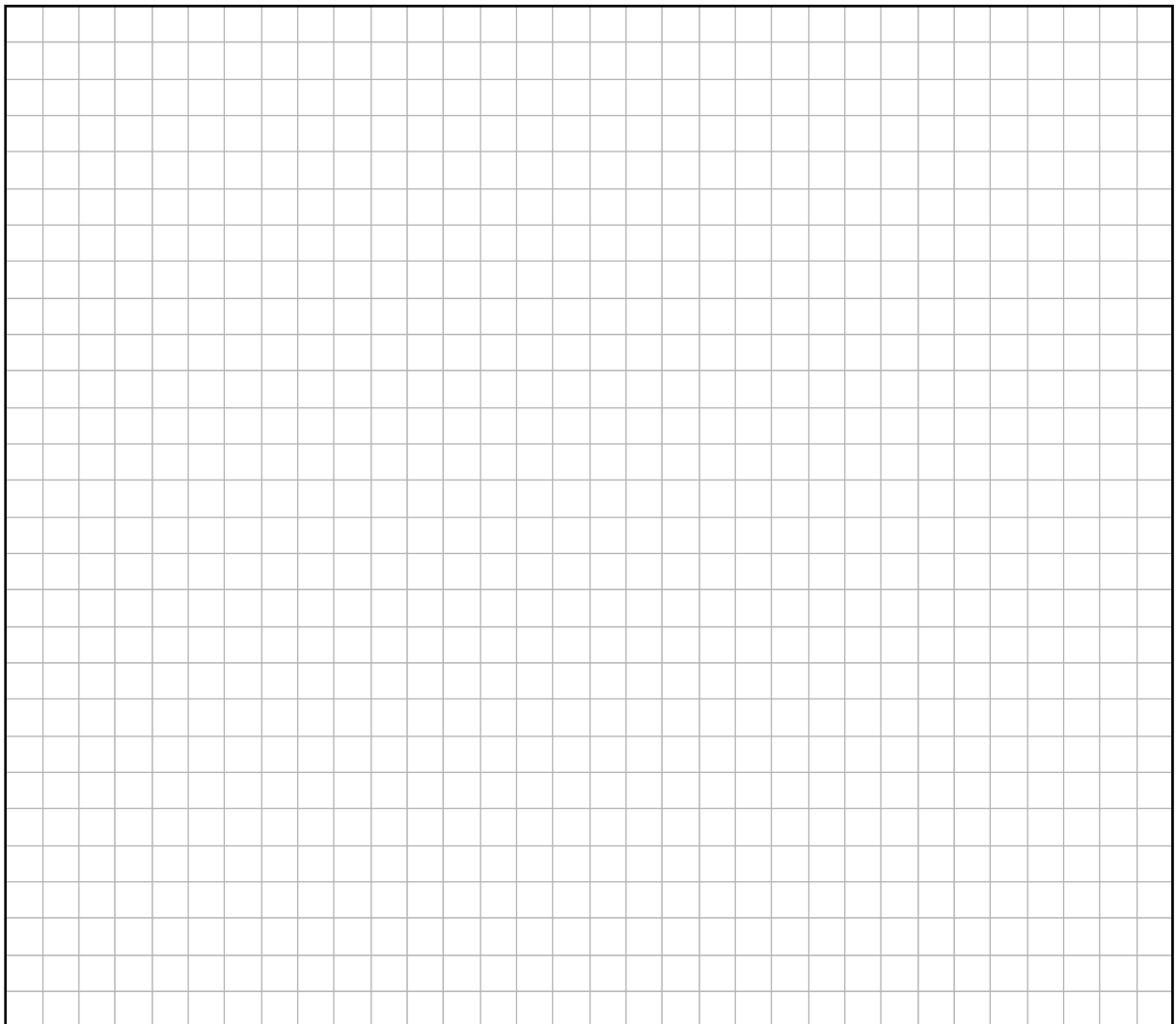
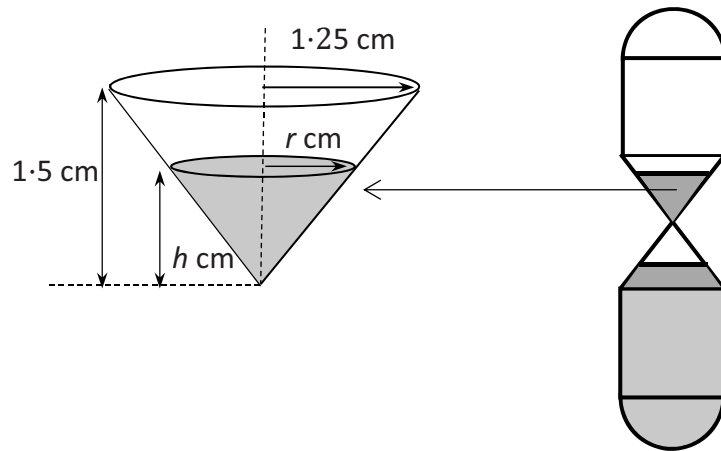

Question 8

(45 marks)

(a) A motoring magazine collected data on cars on a particular stretch of road. Certain details on 800 cars were recorded.

- (i)** The ages of the 800 cars were recorded. 174 of them were new (less than 1 year old). Find the 95% confidence interval for the proportion of new cars on this road. Give your answer correct to 4 significant figures.

- (ii)** The data on the speeds of these 800 vehicles is normally distributed with an average speed of 87.3 km per hour and a standard deviation of 12 km per hour. What proportion of cars on this stretch of road would you expect to find travelling at over 95 km per hour?

Question 9

(55 marks)

The diagram below shows a triangular patch of ground $\triangle SGH$, with $|SH| = 58$ m, $|GH| = 30$ m, and $\angle GHS = 68^\circ$. The circle is a helicopter pad. It is the incircle of $\triangle SGH$ and has centre P .

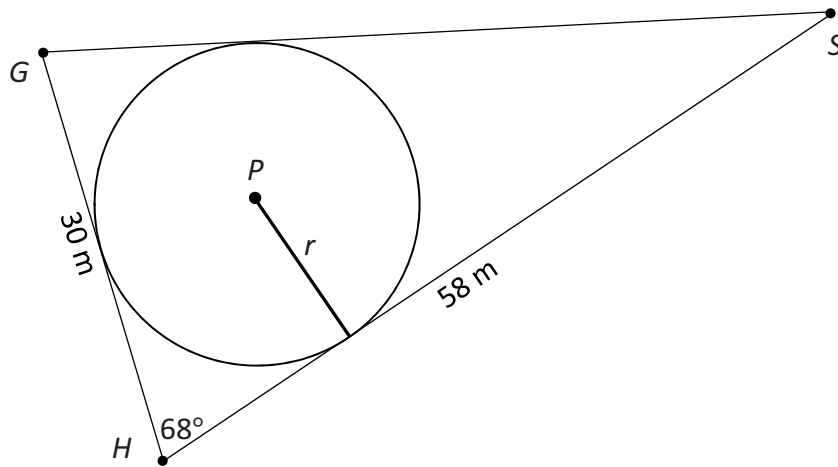

- (a) Find $|SG|$. Give your answer in metres, correct to 1 decimal place.

- (b) Find $|\angle HSG|$. Give your answer in degrees, correct to 2 decimal places.

(c) Find the area of $\triangle SGH$. Give your answer in m^2 , correct to 2 decimal places.

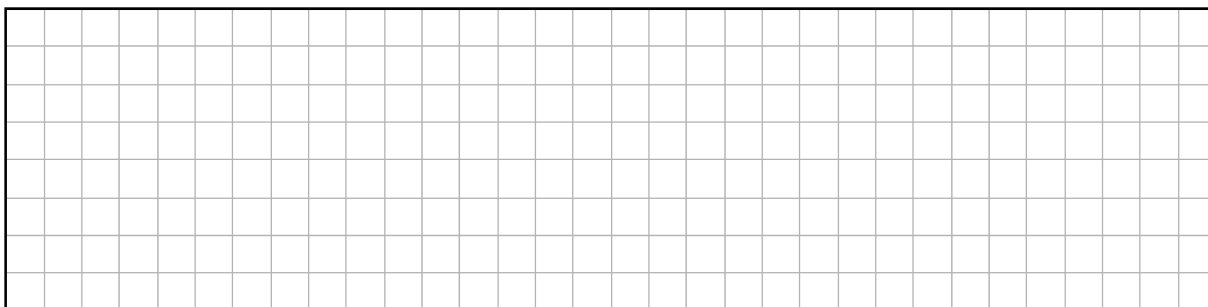

(d) (i) Find the area of $\triangle HSP$, in terms of r , where r is the radius of the helicopter pad.

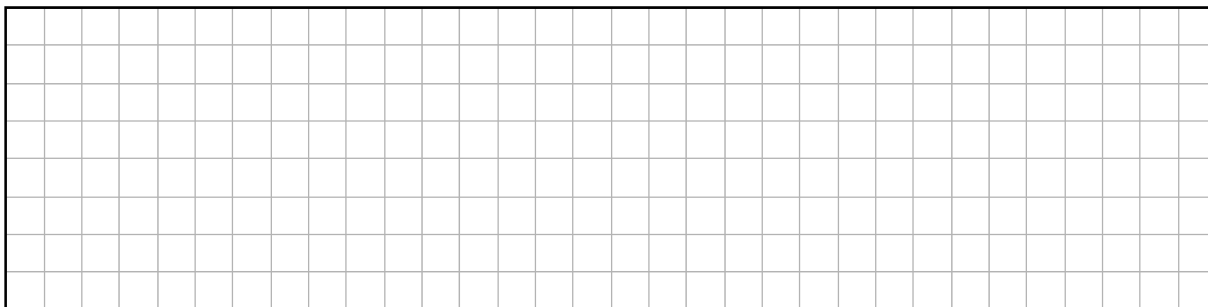

(ii) Show that the area of $\triangle SGH$, in terms of r , can be written as $71 \cdot 2r \text{ m}^2$.

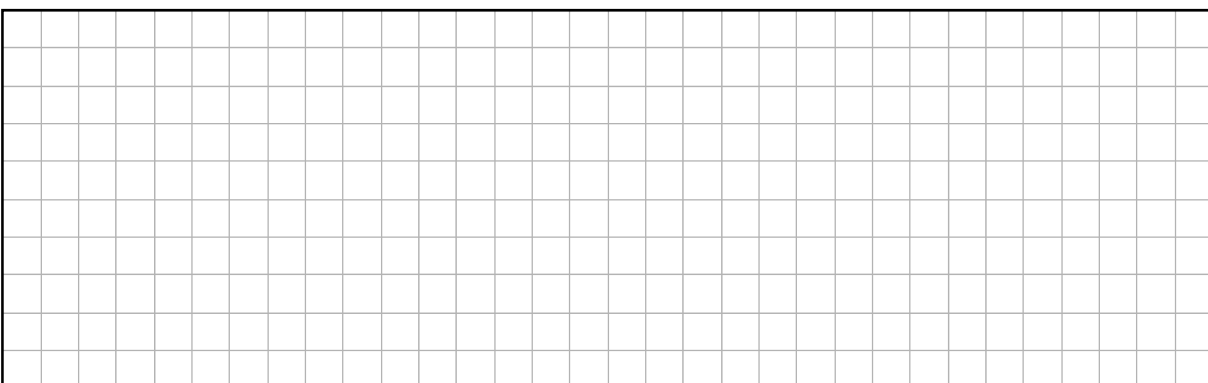

(iii) Find the value of r . Give your answer in metres, correct to 1 decimal place.

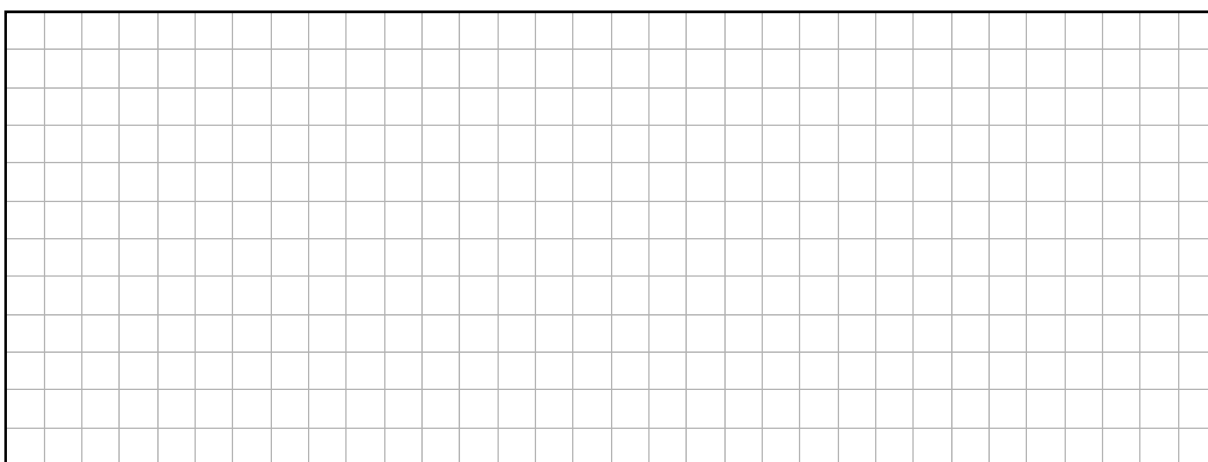

This question continues on the next page.



- (e) $[ST]$ is a **vertical** pole at the point S .
 The angle of elevation of the top of the pole from the point P is 14° .
 Find the height of the pole.
 Give your answer, in metres, correct to 1 decimal place.

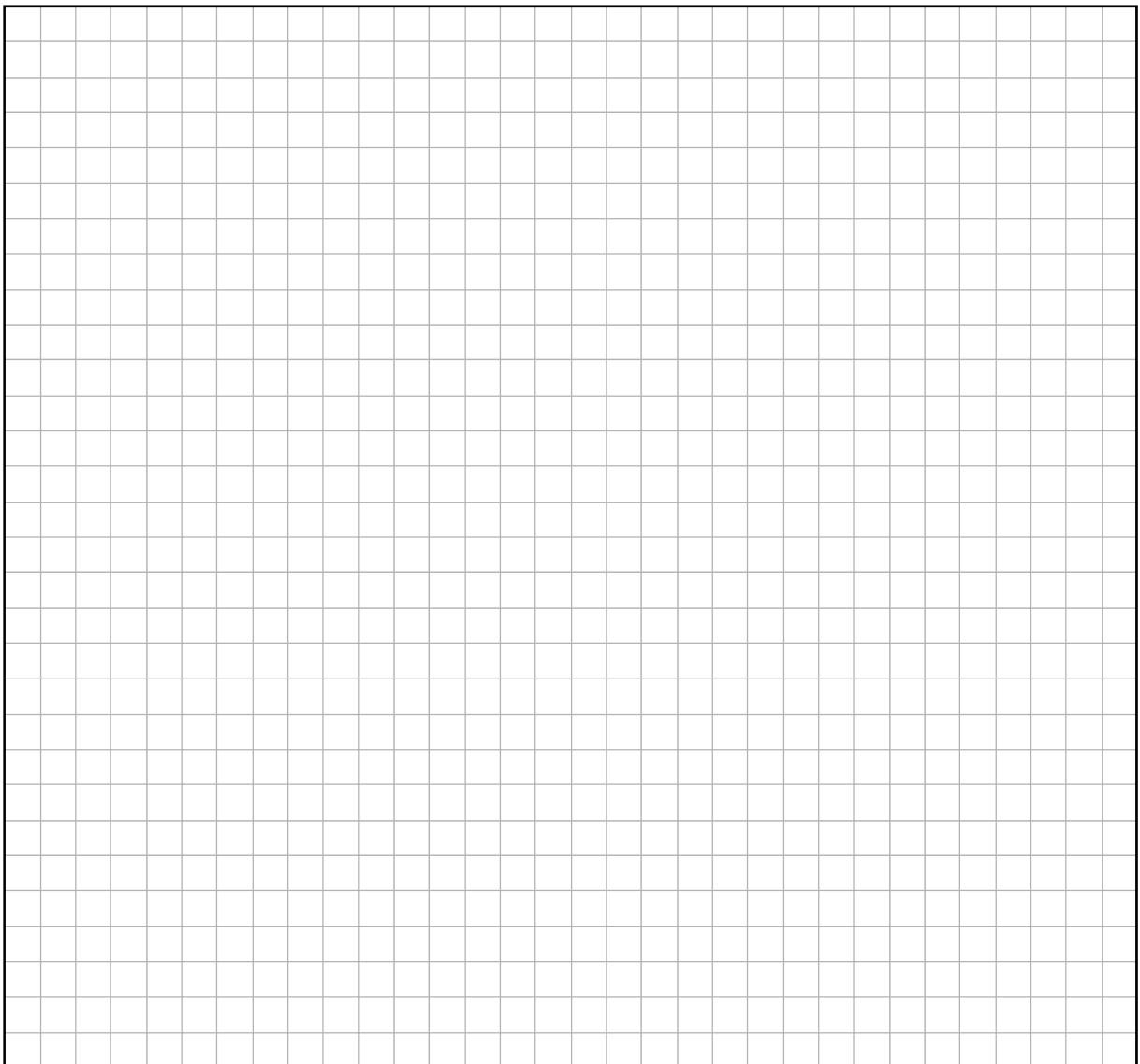
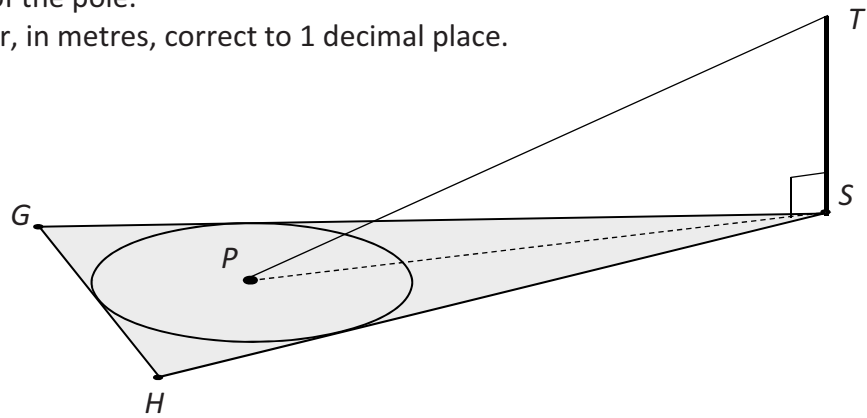

You may use this page for extra work.
Label any extra work clearly with the question number and part.

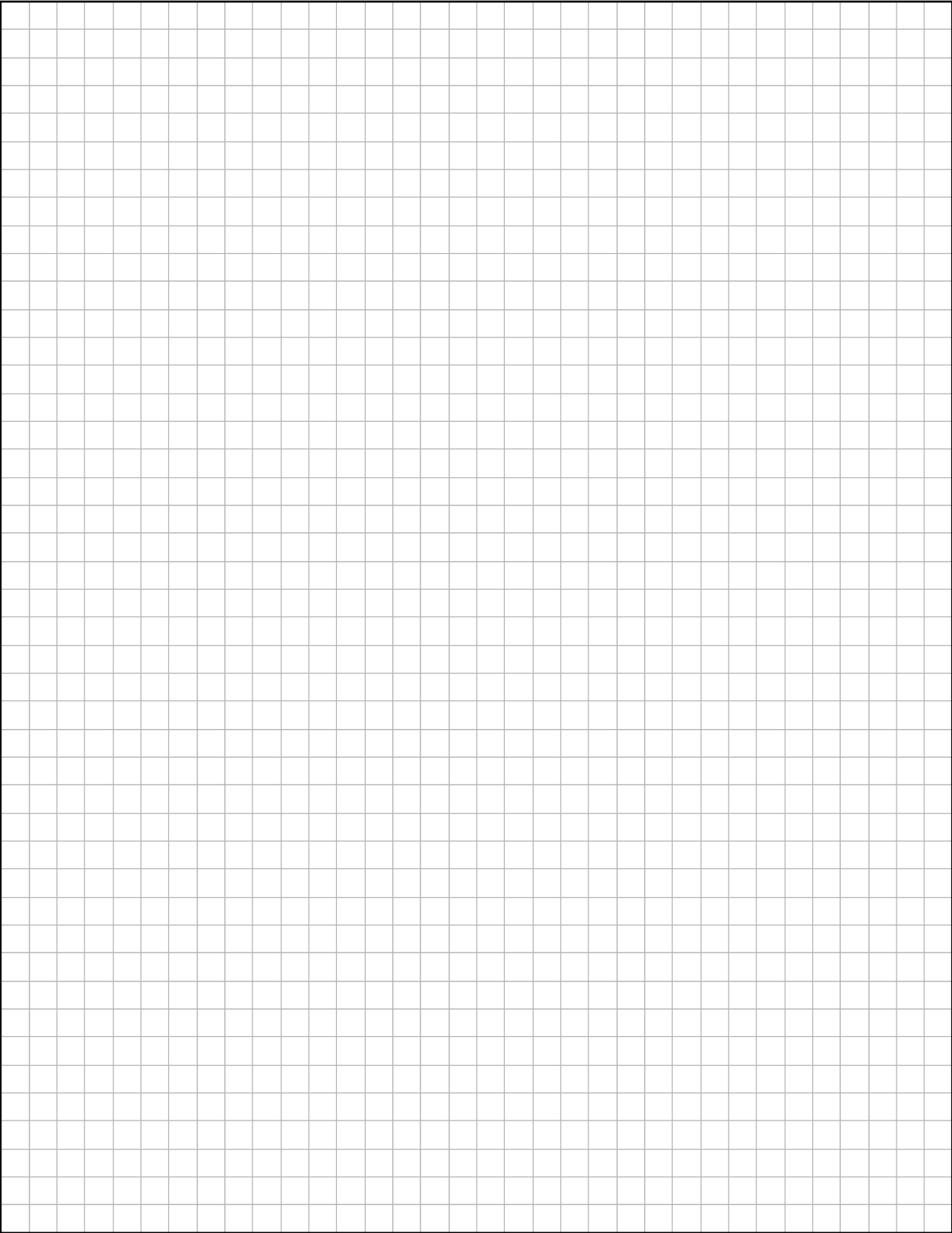

You may use this page for extra work.
Label any extra work clearly with the question number and part.

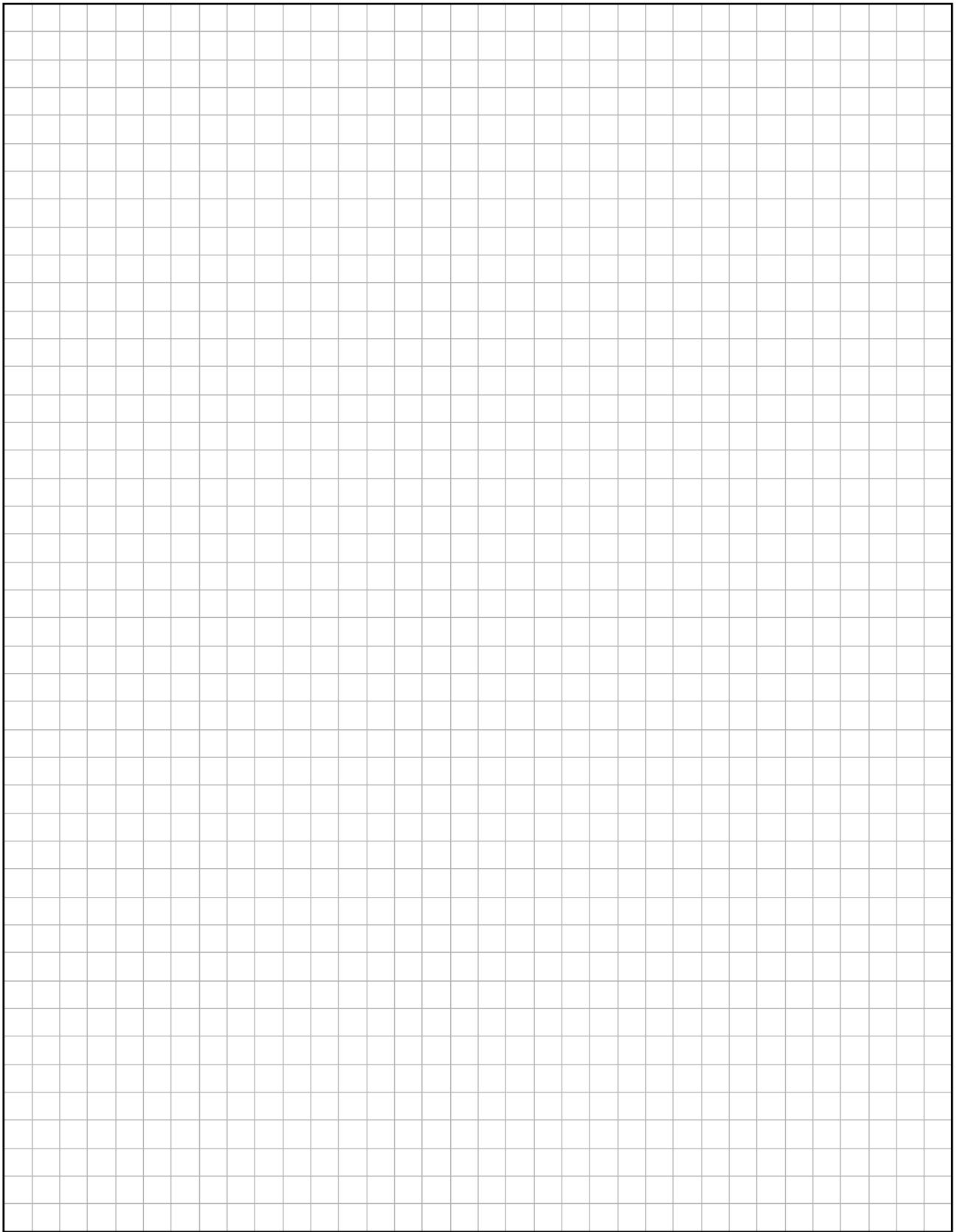

You may use this page for extra work.
Label any extra work clearly with the question number and part.

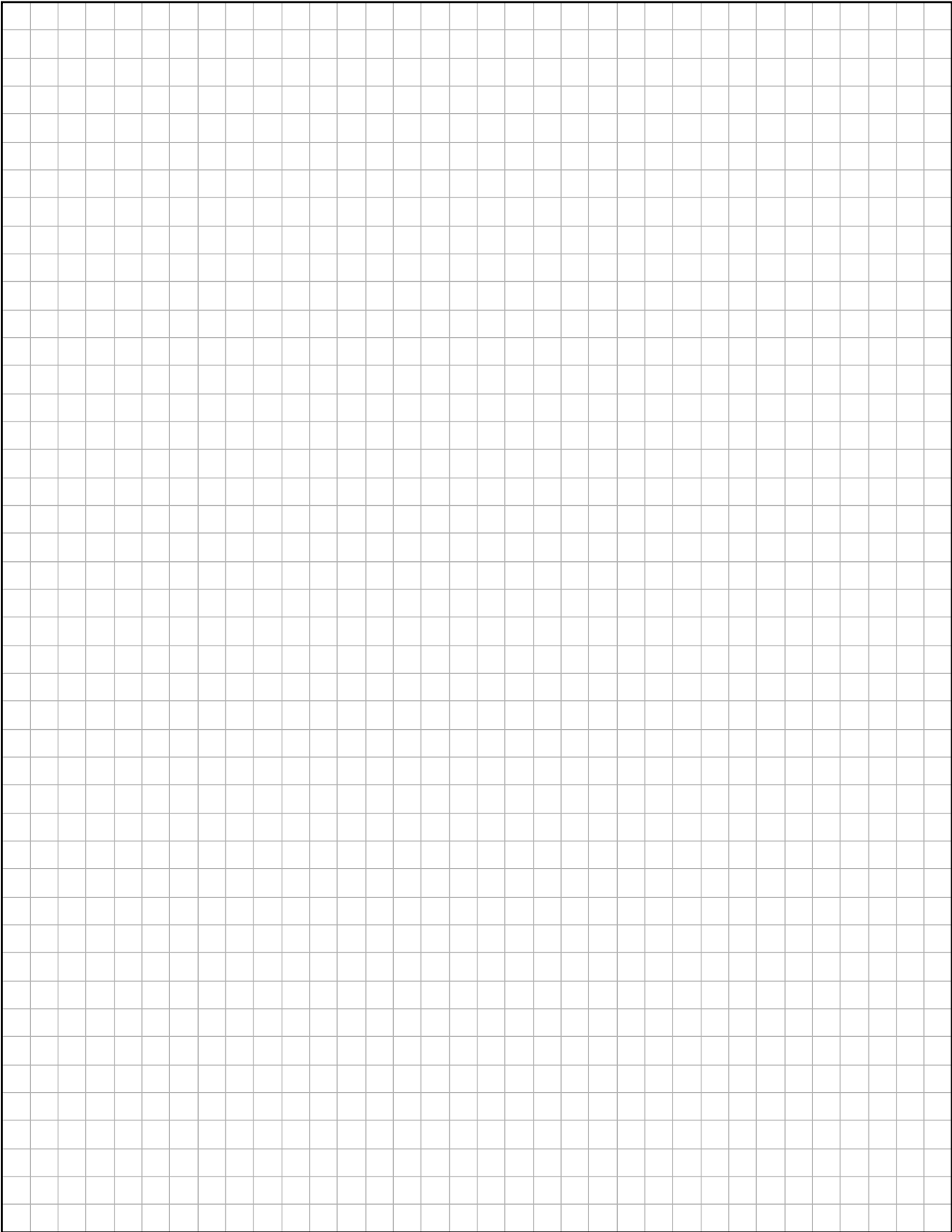

You may use this page for extra work.
Label any extra work clearly with the question number and part.

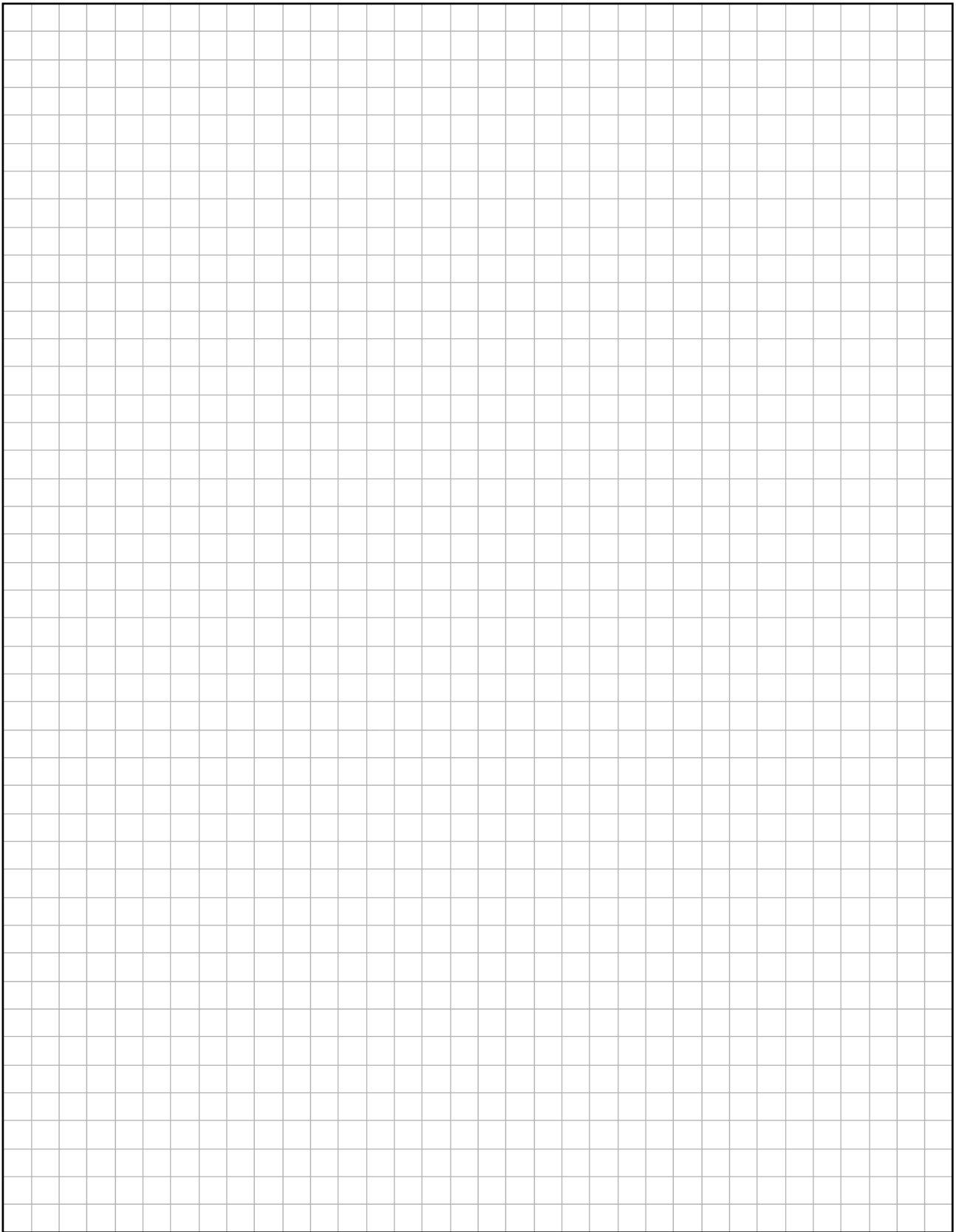

Leaving Certificate 2019 – Higher Level

Mathematics – Paper 2

Monday 10 June
Morning 9:30 to 12:00



2019L003A2EL2828